

ALTEC
LANSING CORPORATION

**438A
AMPLIFIER**

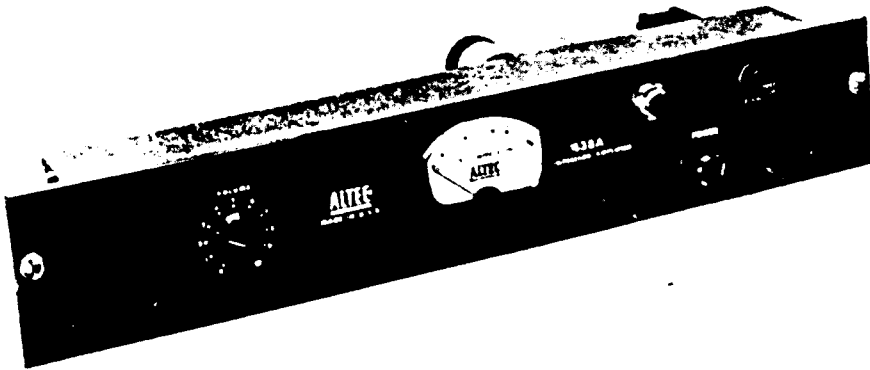

OPERATING INSTRUCTIONS

SPECIFICATIONS

Type:	Compressor Amplifier
Gain:	90 db from Microphone input; 40 db bridging 600 ohm line
Input Sensitivity:	6.5 millivolts on Bridging input to reach compression threshold
Maximum Compression:	30 db (50 db change in input results in 20 db change in output)
Power Output:	+19 dbm at 30 db compression; +24 dbm as straight amplifier
Frequency Response:	± 1.5 db, 40 to 10,000 cps
Input Impedance:	Bridging, 20,000 ohms unbalanced
Source Impedance:	Microphone input, 30/50 ohms
Load Impedance:	150 and 600 ohms
Noise Level:	Gain control at max., -119 dbm equivalent input noise, Microphone input Gain control at min., -50 dbm output noise level
Controls:	Gain, AC power switch
Power Supply:	117 volts, 60 cps, 22 watts
Tubes:	12AY7, 6BC8, 6CG7, 6AL5
Dimensions:	19" L, 3½" H, 6" D
Color:	Metallic Gray
Weight:	8½ lbs.
Special Features:	Compression meter
Attack Time:	50 milliseconds
Recovery Time:	1 second for 63% recovery
Harmonic Distortion:	At 25 db of compression, less than 1.5%, 35 to 15,000 cps At 30 db of compression, less than 2.5%, 35 to 10,000 cps
Accessories:	12495 Cabinet

It is desired to automatically fade "background" music for announcements, start with an approximately mid-scale setting for the 438A gain control and set the control of the music channel so that for average music level the compressor threshold is barely reached. Proper listening level is then set by means of the power amplifier gain control. The voice gain control(s) is then adjusted to provide approximately 25 db of compression, as shown on the meter, during normal announcements. If the voice channel has insufficient gain to provide the latter condition, re-establish all settings starting with a 3/4 or higher scale setting for the 438A gain control.

The above settings will result in announcements at a level approximately 15 db above the original music level. At the same time, during announcements the music will drop automatically to a level about 40 db below the announcement level.

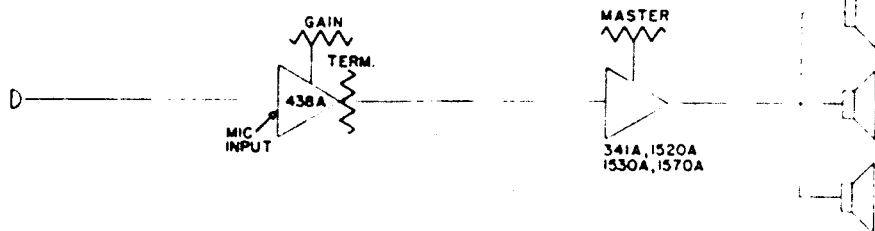

FIG. 1. 438A Amplifier driven by low impedance microphone and driving any Altec power amplifier without added transformer. A 600-ohm terminating resistor must be connected across the 438A output for amplifiers shown. Add fixed or variable attenuation ahead of 260A Amplifier.

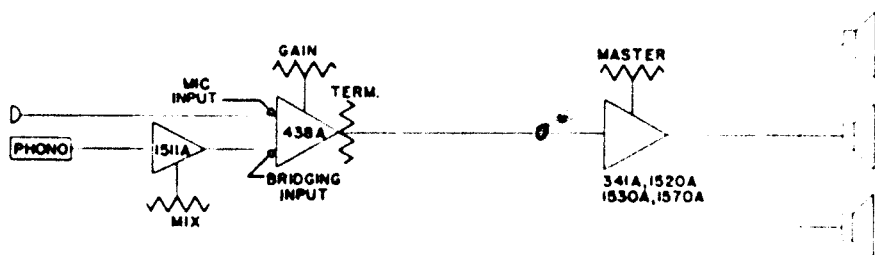

FIG. 2. 438A driven by both microphone and phono circuit for voice-over-music operation. Use R17 build-out resistor in 1511A. Any equipment substituted for 1511A must have its own level control and a build-out resistor of at least 40,000 ohms.

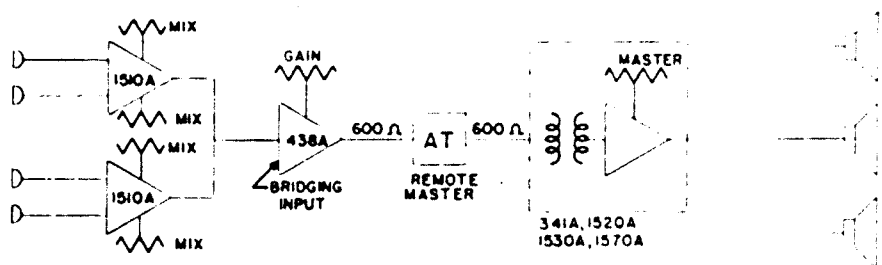

FIG. 3 Typical system using Bridging input of 438A Amplifier. The remote master provides proper termination for the 438A and the transformer provides additional gain for the power amplifier.

Compression Meter

It is usually desirable to have the compression meter visible from the operating position. When conditions dictate a remote location for the 438A Amplifier, an Altec #6049 meter should be ordered for installation at the console. The additional meter is connected in parallel with the 438A Amplifier meter by means of a pair of wires extended to the console location.

Servicing

All circuit components are easily reached by opening the hinged front panel of the unit. Normal servicing can be done with a volt-meter. All pertinent information is shown on the schematic.

Accessory

The 12495 cabinet is a perforated metal enclosure and cover which may be used to protect the 438A Amplifier when not rack mounted. The optional use of the panel cover will discourage unwarranted tampering with the panel controls.

PARTS LIST

C1	50Mfd. 3V, Cornell Dubilier BBR 50-3
C2	.05 Mfd. 400V, Micomold Tropicap
C3	.005 Mfd. 600V, GMV Disc, Erie Type 811
C4	.5 Mfd. 200V, Hopkins 15-390-7A
C5	.00015 Mfd. 600V, Erie 811-151
C6, 7, 8, 9	.0022 Mfd. 400V, Micomold Tropicap
C10	1 Mfd. 200V, Hopkins 13-390-3
C11	40-40-20 Mfd. 450V, Mallory FP 376.9
C12, 13	100 Mfd. 150V, Mallory FP 116
R1	82,000 ohms \pm 10% 1/2 watt
R2	3900 ohms \pm 10% 1/2 watt
R3	240,000 ohms \pm 10% 1/2 watt
R4, 11, 12, 17	1 megohm \pm 10% 1/2 watt
R5	1800 ohms \pm 10% 1/2 watt
R6	100,000 ohms \pm 10% 1/2 watt
R7, 8, 9, 10	47,200 ohms \pm 1% Deposited Carbon
R13	220 ohms \pm 10% 1/2 watt
R14, 15	220,000 ohms \pm 10% 1/2 watt
R16	34 ohms \pm 1% Deposited Carbon

R18	33,000 ohms \pm 10% 1/2 watt
R19	47,000 ohms \pm 10% 1/2 watt
R20	10,000 ohms \pm 10% 1 watt
R21	6800 ohms \pm 10% 1 watt
T1	Peerless K-308-D
T2	Peerless 4651
T3	Peerless 16402
T4	Peerless 6216
P1	Altec Lansing 12178
M1	Altec Lansing 6049
PL1	Maxda \pm 44
F1	1/2 amp JAG Fuse
S1	Altec Lansing 12180
Rectifier	Sarkes Tarzian 58-D
V1	12AY7 Vacuum Tube
V2	6BC8 Vacuum Tube
V3	6CG7 Vacuum Tube
V4	6AL5 Vacuum Tube

DESCRIPTION

The 438A Compressor Amplifier is a self-powered unit capable of driving any Altec power amplifier to full output from low impedance microphone, and provide at the same time up to 30 db compression. It occupies 3½" of rack space and is equipped with level control, power switch, fuse, pilot light and compression meter mounted on a hinged front panel. It is provided with two inputs: a Microphone input equipped with an input transformer connected to accommodate a 30/50 ohm microphone; and a Bridging input of 20,000 ohms impedance which may be used on unbalanced lines of any impedance up to that value, or above if the bridging loss is not excessive for the application. The gain control is effective for either input. Output loads of 150 or 600 ohms may be accommodated. The threshold and amount of compression, as well as the attack and recovery time of the circuit, are fixed quantities considered optimum for average program service.

APPLICATIONS

The 438A Amplifier is intended for use in automatic level control applications in recording, TV broadcasting and public address systems. Level differences caused by individual voice intensities and unequal distances of performers from the microphone can be minimized by its use. The Bridging input permits the 438A Compressor to be used to control level differences between two or more program sources or for automatic fading for voice-over-music announcements. In industrial locations where sudden high level sounds might cause "blasting" with attendant danger to amplifiers and loudspeakers, the 438A Amplifier will prevent such overloading. Altec compressor amplifiers are also being used in TV broadcast pickup of variety, dramatic, musical and operatic productions to minimize level disparities and to relieve the control operator from the need for over-compensating for unpredictable bursts of volume.

The 438A can be used without compressor action by simply removing the 6AL5 tube from its socket.

INSTALLATION AND OPERATION

Figures 1, 2 and 3 illustrate several system arrangements using the 438A compressor both as a preamplifier-line amplifier and as a line amplifier only. The Microphone input will accommodate a substantial range of microphone impedance, such as 30 to 75 ohms. For simultaneous use of the Bridging and Microphone inputs, the source connected to the Bridging input must be at least 40,000 ohms or a build-out resistor of that value employed. Under this condition the gain from Microphone input is reduced 3½ db or less. Using only the Bridging input, the 438A Compressor Amplifier may be connected into any high or low impedance unbalanced line between preamplifiers and power amplifiers without build-out resistor, adapters or other modification, and without the need to add an input gain control.

In high-impedance lines, as exemplified by the Altec Lansing 1500 series P.A. amplifiers, the Bridging input of the 438A Amplifier provides a suitable load for the mixer-preamplifiers. The output of the 438A Amplifier, when terminated with 600 ohms resistance, is of sufficient level to operate directly into the high impedance of the power amplifiers.

Where it is desired to insert the 438A into a transmission line of 500/600 ohms, a resistive termination of 600 ohms should be installed and the Bridging input of the 438A Amplifier connected across this load. The 600 ohm output then provides a suitable source for the input of the following power amplifier.

The average gain, compression and level relationships are shown in the curve and table. Since the outputs at high values of compression would overdrive most power amplifiers, it is necessary to install a suitable loss pad at the input of power amplifiers not already equipped with a gain control.

AVERAGE LEVEL RELATIONSHIPS (Gain Control Maximum)

Output Dbm	Volts @ 600 ohms	Compres- sion	Gain Bridging 600 ohms	Bridging Input	
				Volts	Dbm @ 600 ohms
0	0.77	1 db	40 db	.0077	-40
5	1.0	3	37	.02	-32
10	2.5	8	32	0.062	-22
15	4.3	14	26	0.22	-11
20	7.7	28	12	1.9	+8

Level Adjustments

For unattended sound reinforcement systems in lecture halls and other places where the microphone and loudspeaker are in the same room, precautions must be taken to prevent acoustic feedback when no performer is at the microphone. Level-setting procedure for this case is as follows: adjust the level control so that the average voice speaking at a normal distance from the microphone causes the meter on the 438A Amplifier to indicate 5 db of compression. Then, in the absence of the performer, adjust the power amplifier gain to the maximum level available without acoustic feedback. With this level adjustment, the weaker voices are reinforced the maximum possible. Louder voices will automatically be compressed.

Where the microphone is not in the same location as the loudspeaker, input levels to the 438A Compressor Amplifier should be adjusted so that average program material will drive the compressor into 10 to 15 db of compression, as indicated on the meter. System output should then be set for appropriate volume by means of the power amplifier gain control. With the levels adjusted as above, input variations of ±15 db from average program level will result in only ± 5 db change at the output of the 438A Amplifier.

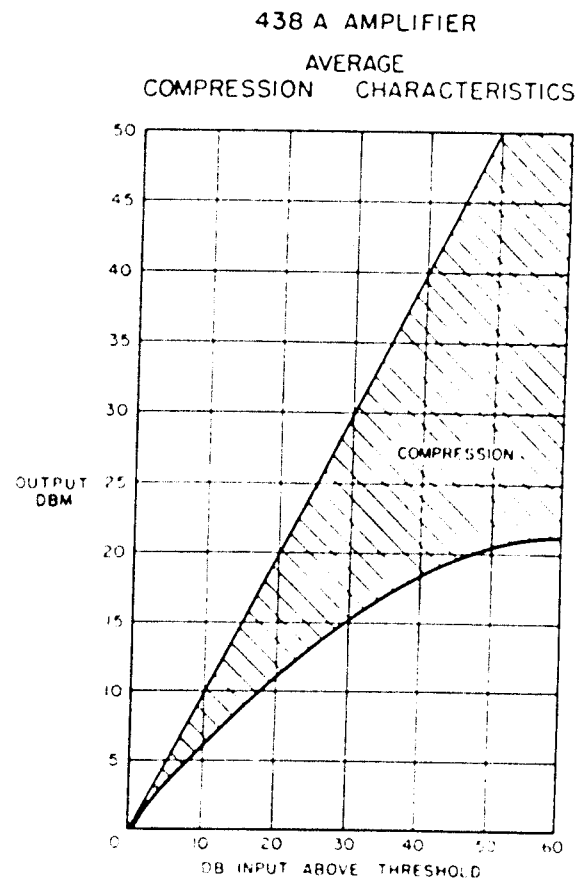

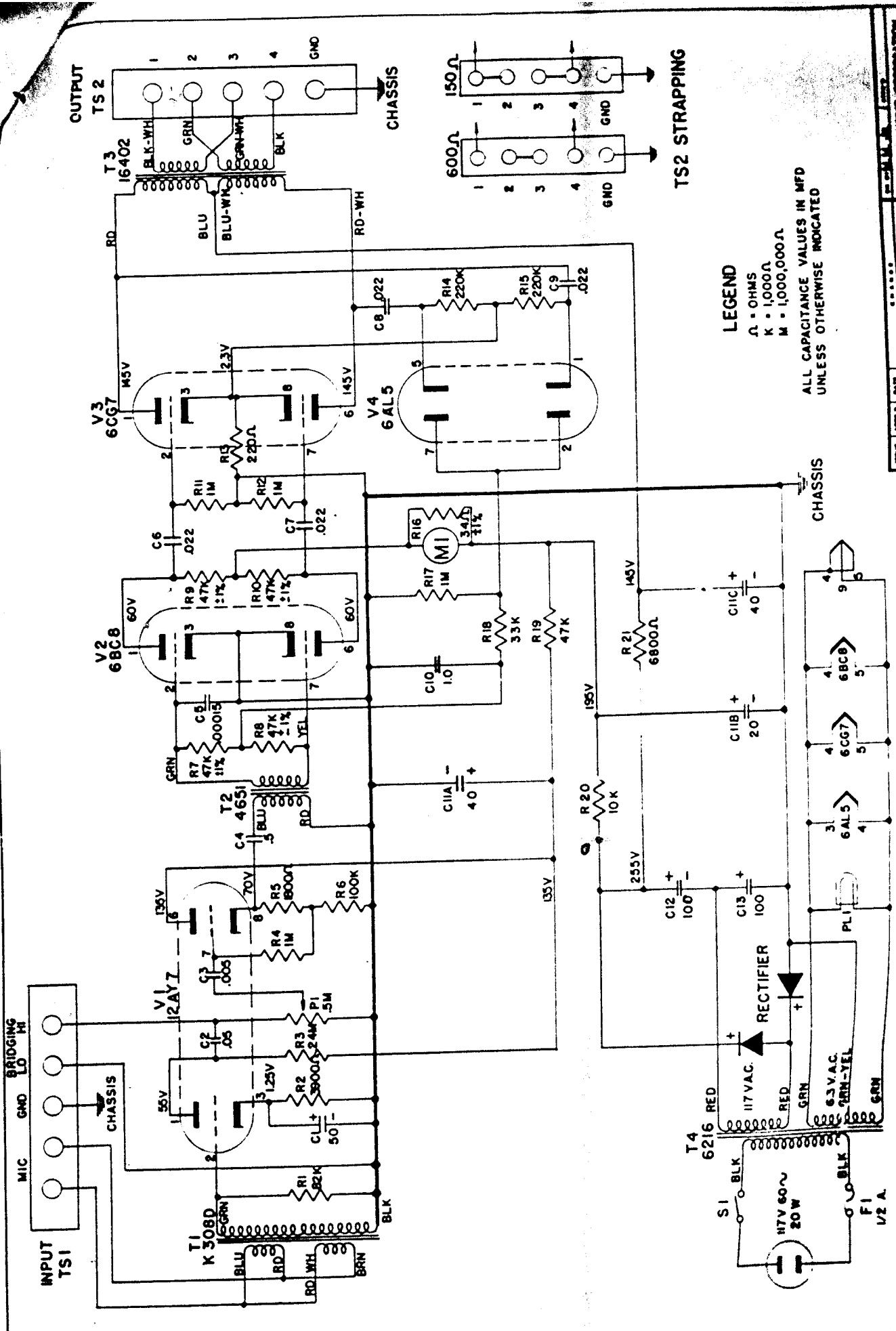

LEGEND
 Ω - OHMS
 K - 1,000Ω
 M - 1,000,000Ω
 ALL CAPACITANCE VALUES IN MFD
 UNLESS OTHERWISE INDICATED

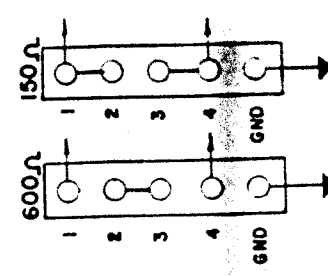

TS2 STRAPPING

ALTEC LANSING 438 A COMPRESSOR AMPLIFIER

REV.	DATE	BY	CHKD.
1	1-4-57		

ALTEC LANSING CORPORATION
 438 A AMPLIFIER
 SCHEMATIC